

Data sheet article FTNT-40-B

Technical data and application safety

Webcraft GmbH
 Industriepark 206
 78244 Gottmadingen, Germany

Phone: +49 7731 939 839 1

www.supermagnete.pt
 support@supermagnete.pt

1. Technical information

neodymium pot magnet Ø 40,2 mm with rotating hook, holds approx. 22 kg, black, with rubberised surface

Article ID	FTNT-40-B
EAN	7640155432535
Material	NdFeB
Strength	approx. 22 kg (approx. 216 N)
Displacement force	approx. 6,6 kg (approx. 64,7 N)
Colour	Black
Design	With rotating hook
Hook opening width a	18 mm
Pot height H	18 mm
Pot diameter D	40,2 mm
Magnetisation	N38
Thickness rubber	0,5 mm
Tolerance	+/- 0,1 mm
Coating	Nickel-coated (Ni-Cu-Ni), powder coated
Shape	Disc
Steel	Q235 (China)
Weight	87,0000 g

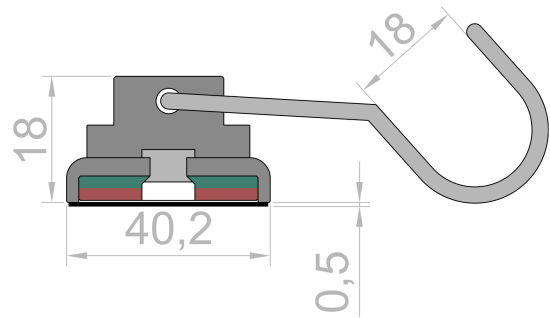



Product compliant with the latest European RoHS directive.



Product compliant with the latest European REACH regulation.

2. Safety tips

<p>Danger</p> 	<p>Swallowing</p> <p>Children could swallow small magnets. If several magnets are swallowed, they could get stuck in the intestine and cause perilous complications.</p> <p>Magnets are not toys! Make sure that children don't play with magnets.</p>
<p>Warning</p> 	<p>Contusions</p> <p>Big magnets have a very strong attractive force.</p> <ul style="list-style-type: none"> • Unsafe handling could cause jamming of fingers or skin in between magnets. This may lead to contusions and bruises. • Powerful, very large magnets could cause bone fractures. <p>Wear heavy protective gloves when handling larger magnets.</p>

<p>Warning</p> 	<p>Pacemaker</p> <p>Magnets could affect the functioning of pacemakers and implanted heart defibrillators.</p> <ul style="list-style-type: none"> • A pacemaker could switch into test mode and cause illness. • A heart defibrillator may stop working.
	<ul style="list-style-type: none"> • If you wear these devices keep sufficient distance to magnets: www.supermagnete.pt/faq/distance • Warn others who wear these devices from getting too close to magnets.

<p>Warning</p> 	<p>Heavy objects</p> <p>Too heavy loads, symptoms of fatigue as well as material defect could cause a magnet or magnetic hook to loosen from the surface that it was attached to.</p> <p>Falling objects could lead to serious injuries.</p>
	<ul style="list-style-type: none"> • The indicated adhesive force applies only to ideal conditions. Allow for a high safety cushion. • Don't use magnets in places where people could sustain injuries in case of material failure.

<p>Warning</p> 	<p>Metal splinters</p> <p>Neodymium magnets are brittle. Colliding magnets could crack.</p> <p>Sharp splinters could be catapulted away for several meters and injure your eyes.</p>
	<ul style="list-style-type: none"> • Avoid the collision of magnets. • Wear safety glasses when handling larger magnets. • Make sure that nearby people are also protected or keep their distance.

3. Handling and storing

<p>Caution</p> 	<p>Magnetic field</p> <p>Magnets produce a far-reaching, strong magnetic field. They could damage TVs and laptops, computer hard drives, credit and ATM cards, data storage media, mechanical watches, hearing aids and speakers.</p>
	<ul style="list-style-type: none"> • Keep magnets away from devices and objects that could be damaged by strong magnetic fields. • Please refer to our table of recommended distances: www.supermagnete.pt/faq/distance

<p>Caution</p> 	<p>Combustibility</p> <p>When machining magnets, the drilling dust could easily ignite.</p>
	<p>Stay away from machining magnets or use appropriate tools and sufficient cooling water.</p>

<p>Caution</p> 	<p>Nickel allergy</p> <p>Many of our magnets contain nickel, also those without nickel coating.</p> <ul style="list-style-type: none"> • Some people have an allergic reaction when they come into contact with nickel. • Nickel allergies could develop from perpetual contact with nickel-plated objects.
	<ul style="list-style-type: none"> • Avoid perpetual skin contact with magnets. • Avoid contact with magnets if you already have a nickel allergy.

<p>Notice</p> 	<p>Influence on people</p> <p>According to the current level of knowledge, magnetic fields of permanent magnets do not have a measurable positive or negative influence on people. It is unlikely that permanent magnets constitute a health risk, but it cannot be ruled out entirely.</p>
	<ul style="list-style-type: none"> • For your own safety, avoid constant contact with magnets. • Store large magnets at least one metre away from your body.

Notice 	<p>Splintering of coating</p> <p>Most of our neodymium magnets have a thin nickel-copper-nickel coating to protect them from erosion. This coating could splinter or crack due to collision or large pressure. This makes them vulnerable to environmental influences like moisture and they could oxidise.</p> <ul style="list-style-type: none"> • Separate big magnets, especially spheres, with a piece of cardboard. • Avoid collisions of magnets as well as repeated mechanical exposure (e.g. blows, bashes).
--	--

Notice 	<p>Oxidation, corrosion, rust</p> <p>Untreated neodymium magnets oxidise quickly and disintegrate. Most of our magnets have a nickel-copper-nickel coating to protect them from corrosion. This coating provides some protection against corrosion, but it is not robust enough for continuous outdoor use.</p> <ul style="list-style-type: none"> • Use magnets only in the dry indoors or protect them against environmental influences. • Avoid damages to the coating.
--	---

Notice 	<p>Temperature resistance</p> <p>Depending on the magnet type, neodymium magnets have a maximum working temperature of 80 to 200 °C. Very thin neodymium magnets and magnets with N52 magnetisation have a maximum working temperature of 65 °C. Most neodymium magnets lose part of their adhesive force permanently at a temperature of 80°C.</p> <ul style="list-style-type: none"> • Don't use magnets in places where they are exposed to extreme heat. • If you use an adhesive, don't harden it with hot air. • Please note our overview of temperature resistance.
--	---

Notice 	<p>Mechanical treatment</p> <p>Neodymium magnets are brittle, heat-sensitive and oxidise easily.</p> <ul style="list-style-type: none"> • When drilling or sawing a magnet with improper tools, the magnet may break. • The emerging heat may demagnetise the magnet. • The magnet will oxidise and disintegrate due to the damaged coating. <p>Avoid machining magnets if you do not have the necessary machines and experience. Let us provide you with an offer for a custom-made order instead: www.supermagnete.pt/custom_form.php</p>
---	--

4. Transportation tips

Caution 	<p>Airfreight</p> <p>Magnetic fields of improperly packaged magnets could influence airplane navigation devices. In the worst case it could lead to an accident.</p> <ul style="list-style-type: none"> • Airfreight magnets only in packaging with sufficient magnetic shielding. • Please refer to the respective regulations: www.supermagnete.pt/faq/airfreight
---	--

Caution 	<p>Postage</p> <p>Magnetic fields of improperly packaged magnets could cause disturbances in sorting machines and damage fragile goods in other packages.</p> <ul style="list-style-type: none"> • Please refer to our shipping tips: www.supermagnete.pt/faq/shipping • Use a large box and place the magnet in the middle surrounded by lots of padding material. • Arrange magnets in a package in a way that the magnetic fields neutralise each other. • If necessary, use sheet iron to shield the magnetic field. • There are stricter rules for airfreight: Refer to the warning notice "Airfreight".
---	---

5. Disposal tips

Small amounts of used neodymium magnets can be thrown out with the regular trash. Larger amounts of magnets need to be recycled as scrap metal.

6. Statutory provisions

Please note that the export of neodymium magnets to the US, Canada and Japan may be subject to patent restrictions. We recommend that you clarify the legal aspects before exporting to these countries.

TARIC-Code: 8302 5000 00 0

Origin: China

For more information about magnets please review
<https://www.supermagnete.pt/faqs>.

Last update: 21/11/2024